

TR160 Platter Dimensions

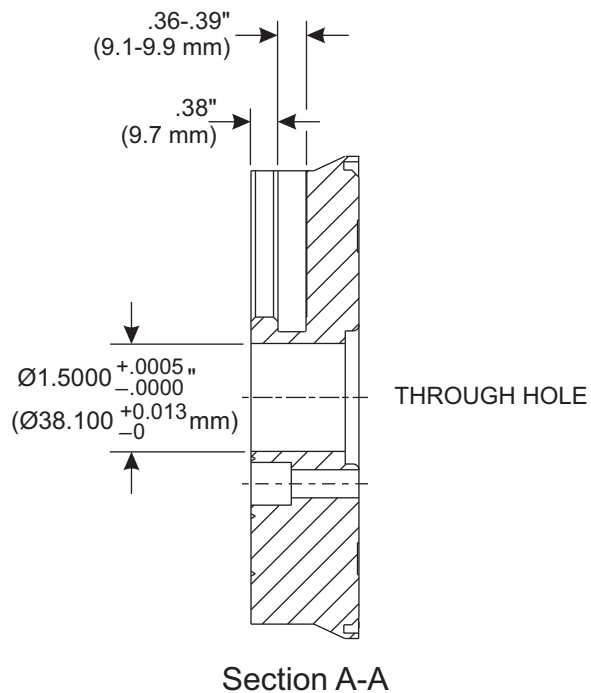
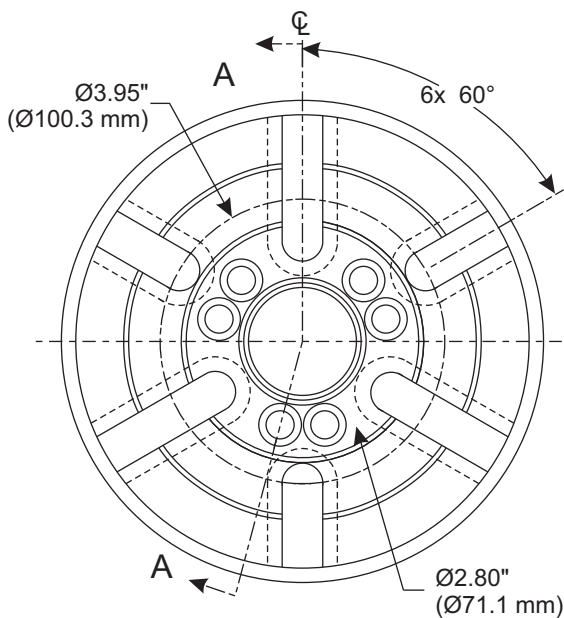
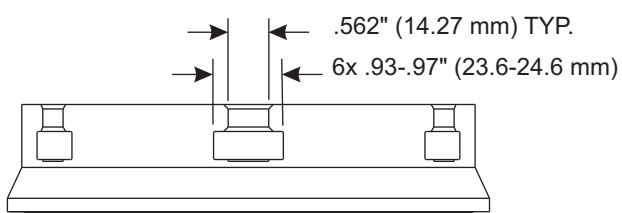

For mounting instructions, see Rotary Operator's Manual.

Go to www.haascnc.com for further rotary specifications.